

# IV and CV Characterizations of Solar/ Photovoltaic Cells Using the B1500A

Application Note B1500A-14

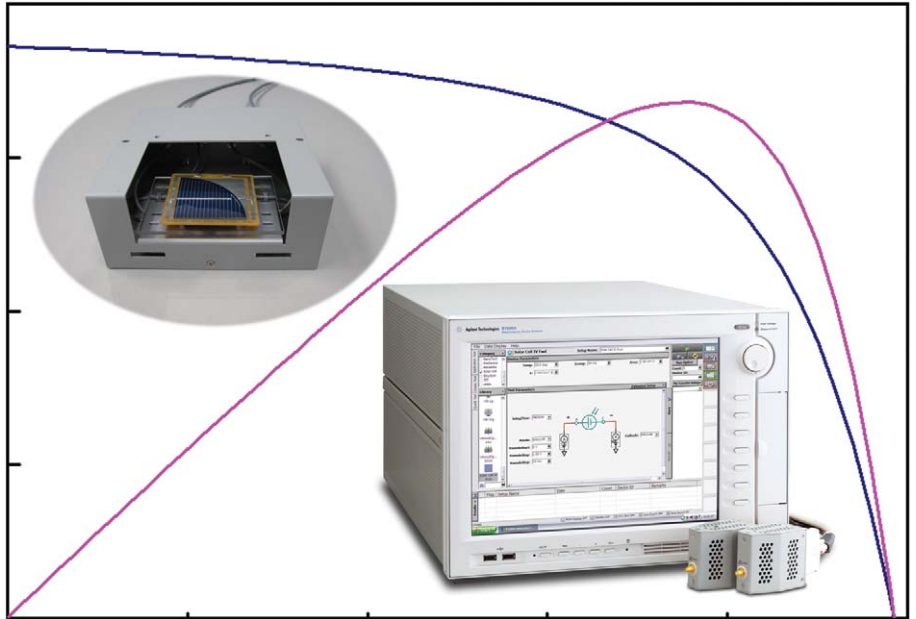

## Introduction

The strong demand for alternatives to fossil fuel based energy sources and growing environmental concerns have increased interest in solar cells as a long-term, exhaustless, environmentally friendly and reliable energy technology. Continuous efforts to develop various types of solar cells are being made in order to produce solar cells with improved efficiencies at a lower cost, thereby taking advantage of the vast amounts of free energy available from the sun.

The Agilent B1500A Semiconductor Device Analyzer is a well-known tool for evaluating the characteristics of semiconductor devices. However, it can also be a very effective tool for solar cell characterization since most solar cell measurements are the same as those for semiconductor devices, such as current versus voltage (IV) and capacitance versus voltage (CV) measurements. This application note shows how the B1500A can be used to evaluate a variety of solar cell types, from conventional devices based on silicon to state-of-the-art devices using more exotic materials.



**Agilent Technologies**

## Solar cell overview

The equivalent circuits used to model the DC and AC behavior of a solar cell are different. Figure 1 shows the equivalent circuit models for these two cases.

The DC equivalent circuit, which describes the static behavior of the solar cell, is commonly composed of a current source, a pn junction diode and a shunt resistor ( $R_{sh}$ ) in parallel along with a series resistor ( $R_s$ ). The current source models electron injection from light.  $R_s$  is the total Ohmic resistance of the solar cell, which is essentially the bulk resistance. Smaller  $R_s$  values equate to increased solar cell efficiencies.  $R_{sh}$  accounts for stray currents, such as recombination currents and leakage currents around the edge of devices. In this case a larger  $R_{sh}$  value equates to increased solar cell efficiency, since it means that the stray currents are reduced.

A three element model is used to model the AC equivalent circuit. The AC equivalent circuit consists of a parallel capacitance ( $C_p$ ), a parallel resistance ( $r_p$ ) and a series resistance ( $r_s$ ). The AC equivalent circuit can be used to describe the dynamic behavior of the solar cell.  $C_p$  consists of a transition capacitance ( $C_t$ ) and a diffusion capacitance ( $C_d$ ) in parallel, which are dependent on the applied voltage. In addition,  $C_d$  also depends on the AC signal frequency. The  $r_p$  resistor is the parallel combination of  $R_{sh}$  and a dynamic resistance ( $R_d$ ) that also shows voltage dependence.

Although there are a variety of types of solar cells under development, the majority of solar cells fabricated today are silicon-based in single crystalline, large-grained poly crystalline or amorphous forms. Silicon is an abundant material, highly stable and possessing a set of well-balanced electronic, physical and chemical properties that are ideal for mass production. These characteristics have made silicon the preferred material for microelectronics and they also account for its predominance in solar cells. However, although there is still some room

for improvement the performance of silicon-based solar cells is approaching theoretical limits. In addition, the potential demand for solar cells exceeds available manufacturing capacity to produce the high quality, pure silicon crystal lattices necessary for optimum solar cell efficiency. This has prompted the development of solar cells based on alternative materials such as a  $\text{Cu(In, Ga)Se}_2$  (CIGS) solar cell and a dye sensitized solar cell (DSC) to improve conversion efficiency and reduce costs.

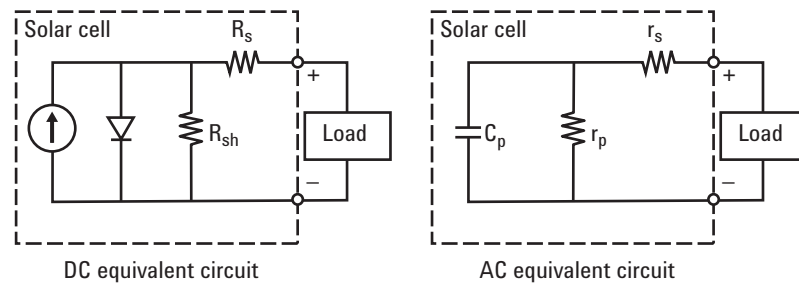

Figure 1. Simplified equivalent circuit diagrams for modeling the DC and AC behavior of a solar cell

Category		Type	Challenges
Silicon		Single crystalline	Development of the device structure
		Polly crystalline	Improvement of the crystal quality
		Amorphous	Multiplying the junctions
Compound	III-V Semiconductors	GaAsInP	Control of the band gap Multiplying the junctions
	II-VI Semiconductors	CdTe/CdS Cu <sub>2</sub> S/CdS	
	Chalcopyrite Semiconductors	CIGS	
Organic		Pentacene Phthalocyanine Merocyanine	Development of the device structure (Including multi-junction) Development of the materials
Photochemical		Dye sensitized	Development of the materials

Table 1. Solar cell types and their associated challenges

## Solar cell parameter extraction

Table 1 summarizes the various types of solar cells and the challenges facing them. Of course, improving energy conversion efficiency is the over-riding challenge facing all of these solar cell types. Improved efficiency helps by both decreasing the amount of expensive material required for cell fabrication and by reducing costs for the peripheral components, thereby lowering the cost per Watt of the solar cell. IV characterization, which will be discussed later, is mandatory to evaluate the parameters which describe the solar cell's efficiency.

In addition to IV measurements, capacitance measurements and time domain measurements are required to completely characterize solar cells. Because traps in the bulk directly affect carrier recombination at the interface and in the bulk, it is essential to characterize these traps so as to minimize their impact on solar cell performance. Capacitance measurements are the main method to evaluate traps in the bulk. Understanding trap behavior is also important when studying multi-junction solar cells and for controlling the solar cell band gap. To optimize solar cell performance it is also important to know the carrier diffusion length, because it is one of the key parameters impacting solar cell efficiency. Time domain measurement is the principal method used to measure carrier diffusion length.

Table 2 lists the parameters that are typically used to characterize solar cells.

### Parameters from IV measurements

Most solar cell parameters can be obtained from simple IV measurements. Figure 2 shows the IV characteristics of a typical solar cell under forward bias and illumination. The short circuit current ( $I_{sc}$ ) is the current through the solar cell when the voltage across the solar cell is zero. The open circuit voltage ( $V_{oc}$ ) is the voltage across the solar cell when the current through the solar cell is zero and it is the maximum voltage available from the solar cell. The maximum power point ( $P_{max}$ ) is the condition under which the

solar cell generates its maximum power; the current and voltage in this condition are defined as  $I_{max}$  and  $V_{max}$  (respectively). The fill factor (FF) and the conversion efficiency ( $\eta$ ) are metrics used to characterize the performance of the solar cell. The fill factor is defined as the ratio of  $P_{max}$  divided by the product of  $V_{oc}$  and  $I_{sc}$ . The conversion efficiency is defined as the ratio of  $P_{max}$  to the product of the input light irradiance (E) and the solar cell surface area ( $A_c$ ).

$$FF = \frac{P_{max}}{V_{oc} \times I_{sc}}$$

$$\eta = \frac{P_{max}}{E \times A_c} = \frac{V_{oc} \times I_{sc} \times FF}{E \times A_c}$$

IV measurement		
Symbol	Parameter Name	Unit
$I_{sc}$	Short circuit current	A
$J_{sc}$	Short circuit current density	A/cm <sup>2</sup>
$V_{oc}$	Open circuit voltage	V
$P_{max}$	Maximum power point	W
$I_{max}$	Current at maximum power point	A
$V_{max}$	Voltage at maximum power point	V
FF	Fill factor	—
$\eta$	Conversion efficiency	%
$R_{sh}$	Shunt resistance	$\Omega$
$R_s$	Series resistance	$\Omega$

Capacitance measurement		
Symbol	Parameter Name	Unit
$C_p$	Parallel capacitance	F
$N_c$	Carrier density	cm <sup>-3</sup>
$N_{dl}$	Drive-level density	cm <sup>-3</sup>

Time domain measurement		
Symbol	Parameter Name	Unit
$\tau$	Minority carrier lifetime	s
S	Surface recombination velocity	cm/s
$L_d$	Minority carrier diffusion length	m

Table 2. Basic solar cell parameters

Although there are a variety of methods to estimate  $R_{sh}$  and  $R_s$ , one of the most straightforward techniques is to measure the slope of IV characteristics as shown in Figure 2. Unfortunately, the value of  $R_s$  calculated using this method tends to be proportional to but larger than the actual value.

To obtain more accurate estimates of  $R_s$ , a series of forward biased IV measurements are made using different values of input light irradiance (please see Figure 3). First, a forward-biased IV measurement under an arbitrary light irradiance is made and a value  $V_1$  that is slightly higher than  $V_{max}$  (as shown in the figure) is selected. Next a value of  $\Delta I$  is calculated where  $\Delta I = I_{sc1}(0) - I_{sc1}(V_1)$ . This process is then repeated two more times using lower values of light irradiance as shown in Figure 3. Finally,  $R_s$  is estimated by averaging  $R_1$ ,  $R_2$  and  $R_3$ , as shown below.

$$R_s = \frac{R_1 + R_2 + R_3}{3}$$

Where

$$R_1 = \frac{V_2 - V_1}{I_{sc1}(V_1) - I_{sc2}(V_2)}$$

$$R_2 = \frac{V_3 - V_2}{I_{sc2}(V_2) - I_{sc3}(V_3)}$$

$$R_3 = \frac{V_3 - V_1}{I_{sc1}(V_1) - I_{sc3}(V_3)}$$

A reverse biased IV measurement under dark current conditions provides the information about  $R_{sh}$  as well. The other method to estimate  $R_{sh}$  is making use of the slope of a reverse biased IV characteristics in the linear region (please see Figure 4).  $R_{sh}$  can be defined as below.

$$R_{sh} = -\frac{1}{dI/dV}$$

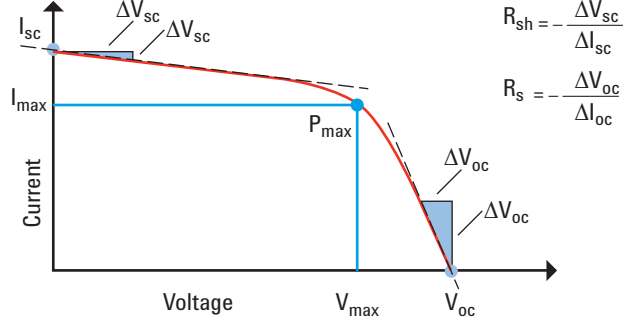

Figure 2. Typical IV forward bias characteristics of a solar cell

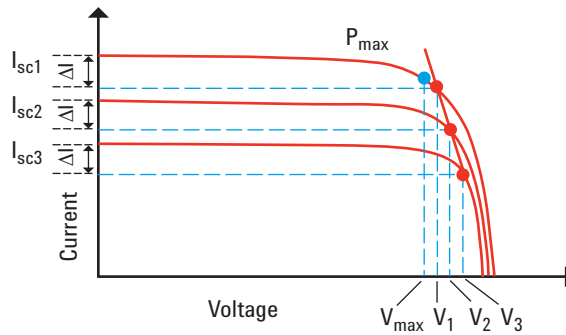

Figure 3. The preferred method for determining series resistance ( $R_s$ ) from solar cell IV characteristics

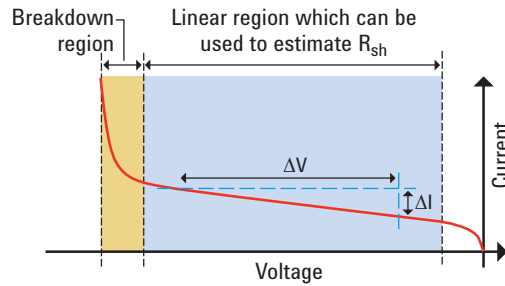

Figure 4. Typical IV characteristics of a solar cell under reverse bias

## Parameters from capacitance measurements

Capacitance measurements can be also used to evaluate the characteristics of solar cells. CV measurements, which are the most common capacitance measurements, can be used to estimate the carrier density ( $N_c$ ) using the following equation.

$$\frac{1}{C^2} = \frac{2}{qN_c K_s \epsilon_0 A^2} (V_{bi} - V)$$

Here  $q$  is the electron charge,  $K_s$  is the semiconductor dielectric constant,  $\epsilon_0$  is the permittivity of free space,  $A$  is the surface area of a solar cell and  $V_{bi}$  is the built-in potential. A  $1/C^2 - V$  plot is called a Mott-Schottky plot, and the  $N_c$  distribution over the depletion width ( $W$ ) is obtained from the slope of Mott-Schottky plot as shown below (please see Figure 5).

$$N_c(W) = \frac{2}{qK_s \epsilon_0 A^2} \left[ \frac{d(1/C^2)}{dV} \right]$$

where

$$W = \frac{K_s \epsilon_0 A}{C}$$

An AC voltage capacitance measurement ( $CV_{ac}$ ) provides the information about the defect density ( $N_d$ ). This technique is known as drive-level capacitance profiling (DLCP), and it is used to determine deep defect densities by studying the non-linear response of the capacitor

$$C = C_0 + C_1 dV + C_2 (dV)^2 + \dots$$

as a function of the peak-to-peak voltage  $dV (=V_{pp})$  of the applied

oscillating signal. The density that can be obtained using DLCP is also called the drive level density ( $N_{dl}$ ), and it is defined as shown below (please see Figure 6). (Note: In the previous equation the subscripted symbols  $C_1$ ,  $C_2$ , etc. have the units of capacitance per volt, capacitance per volt squared, etc.)

$$N_{dl}(W) = - \frac{C_0^3}{2qK_s \epsilon_0 A^2 C_1}$$

where,

$$N_d(W) = - \frac{C_0^2}{2qK_s \epsilon_0 A^2 C_1}$$

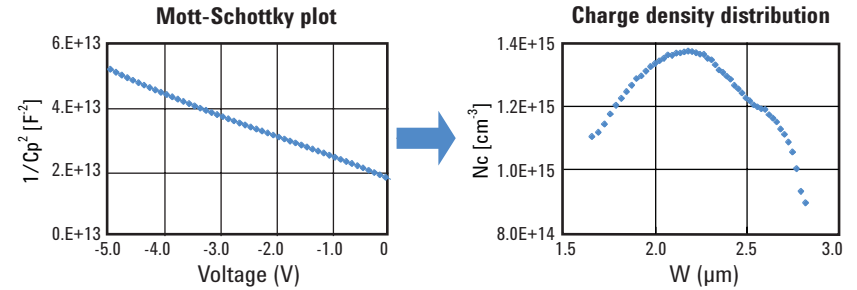

Figure 5. Mott-Schottky plot and charge density distribution

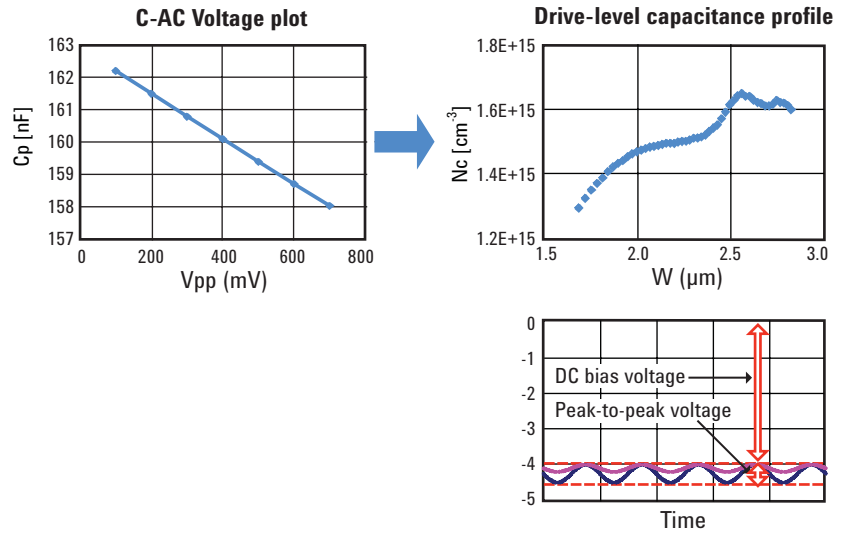

Figure 6. DLCP measurement and  $N_{dl}$  distribution

A capacitance versus frequency (Cf) measurement is helpful to understand the dynamic behavior of solar cells as well. The results of a Cf measurement are often plotted as complex numbers in the impedance plane where this information is known by many names, such as Nyquist plots, Cole-Cole plots, complex impedance plots, etc. (please see Figure 7).

### Parameters from time domain measurements

A variety of time domain measurement methods are also being developed to evaluate the recombination parameters of solar cells, such as minority carrier lifetime ( $\tau$ ), surface recombination velocity (S) and minority carrier diffusion length ( $L_d$ ).

One of the most popular techniques is open circuit voltage decay (OCVD) where the excitation is supplied either electrically or optically (please see Figure 8). In the electrical case a constant current equal to  $I_{sc}$  is forced into the solar cell and the voltage decay across the solar cell is observed after abruptly terminating the current. In the optical case a light pulse is used to stimulate the solar cell instead of a current. For the short circuit condition the current flow across the solar cell is measured after removing the light stimulus, and this is called the short circuit current decay (SCCD).

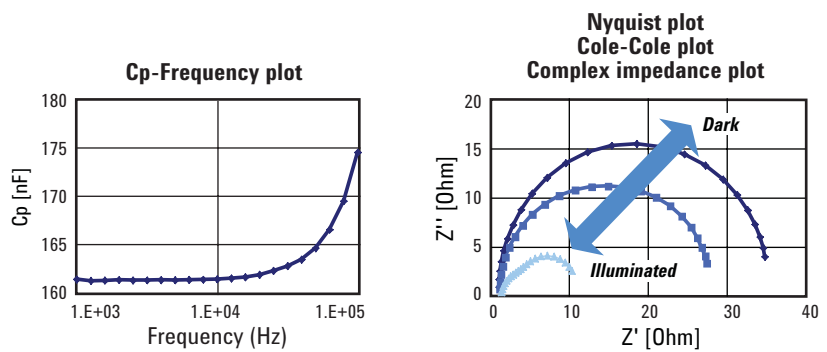

Figure 7. Cp-Frequency plot and Nyquist plot

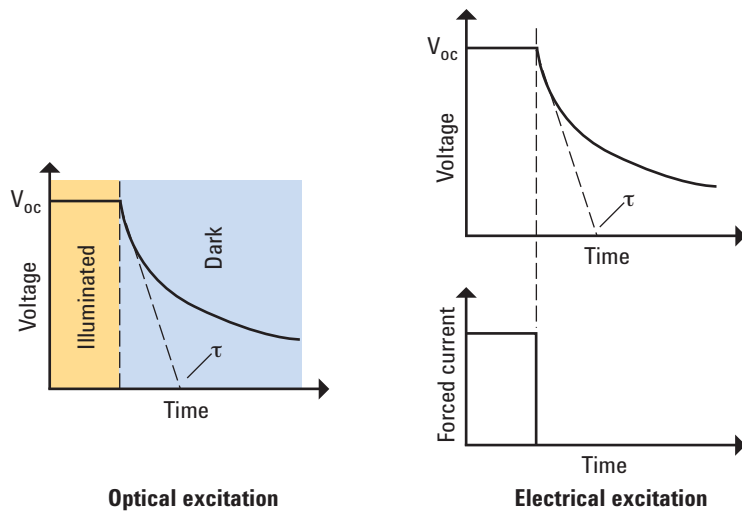

Figure 8. Open circuit voltage decay measurement

# B1500A solar cell test capabilities

The B1500A mainframe has ten slots available for modules and it supports a variety of module types. These include a source/monitor unit (SMU), a multi-frequency capacitance measurement unit (MFCMU), a waveform generator/fast measurement unit (WGFMU) and a high-voltage semiconductor pulse generator unit (HV-SPGU). In addition, every B1500A mainframe includes a ground unit (GNDU); the GNDU acts as an active ground that always maintains a potential of 0 V for current levels of  $\pm 4.2$  A. Using these modules and the ground unit you can perform a wide variety of parametric test, from basic IV and capacitance characterization to ultra-fast IV time domain measurements.

## IV measurement capabilities

As previously discussed, basic solar cell parameters such as  $I_{sc}$ ,  $J_{sc}$ ,  $V_{oc}$ ,  $P_{max}$ ,  $I_{max}$ ,  $V_{max}$ , FF,  $\eta$ ,  $R_{sh}$  and  $R_s$  can be determined from basic IV measurements. The B1500A SMUs can make IV measurements on solar cells across all four quadrants as described below.

SMUs are single-ended devices that combine a current source, a voltage source, a current meter, a voltage meter and several switches (please see Figure 9). SMUs can evaluate the IV characteristics of devices over all four quadrants, enabling the measurement of both illuminated IV characteristics and dark IV characteristics without requiring any external

switches (please see Figure 10). The SMU not only has the capabilities to force/measure voltage or current, but it also has a compliance feature that limits the voltage or current output to prevent device damage. For example, when the SMU is in voltage source mode you can specify a current compliance to prevent large currents from flowing into the device under test (DUT).

The B1500A supports three types of SMUs: a medium power SMU (MPSMU), a high power SMU (HPSMU) and a high resolution SMU (HRSMU). This allows you to select the SMU appropriate for the type of device you are measuring. Table 3 summarizes the different SMU capabilities, and Figure 11 shows the amount of current/voltage that each SMU can force/measure.

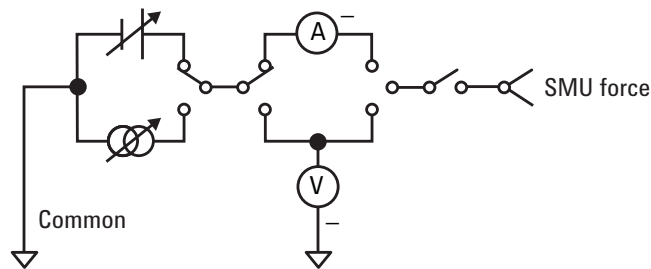

Figure 9. Simplified SMU equivalent circuit

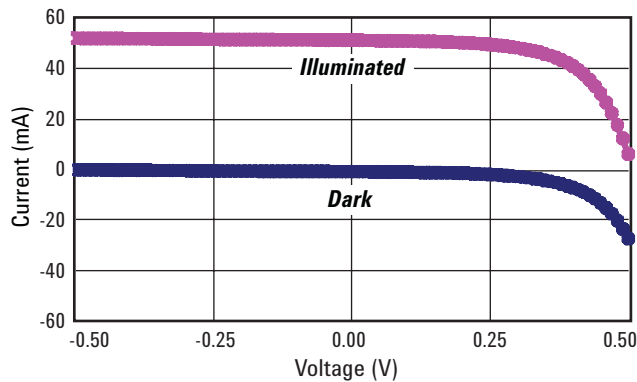

Figure 10. IV measurements made using an SMU

		MPSMU	HPSMU	HRSMU
Maximum values to force/measure(Absolute values)	Current	100 mA	1 A	100 mA
	Voltage	100 V	200 V	100 V
Minimum resolution to measure	Current	10 fA	10 fA	1 fA
	Voltage	0.5 $\mu$ V	2 $\mu$ V	0.5 $\mu$ V
Maximum power		2 W	14 W	2 W

Table 3. Comparison of SMU measurement capabilities

If your solar cells have short circuit currents larger than 1 A or require voltages greater than 200 V, the Agilent B1505A Power Device Analyzer/Curve Tracer can be used to evaluate your devices. The B1505A supports a high current SMU (HCSMU) that can measure currents of up to 20 A and a high voltage SMU (HVSMU) that can measure voltages of up to 3000 V. In addition, the B1505A also supports the HPSMU and the MFCMU modules (the same modules supported on the B1500A). More detailed information about the B1505A can be found in the B1505A brochure (5990-4158EN).

The SMU allows you to specify a delay time parameter when performing sweep measurements. This parameter permits you to stipulate the amount of time to wait after each voltage step change before performing the measurement. This capability is essential for evaluating state-of-the-art devices such as DSCs. These devices show a distinct step delay response (please see Figure 12), making it essential to control the delay time to be able to correctly characterize these devices. The B1500A sweep measurement delay time can be specified with 100  $\mu$ s resolution.

The SMU also supports a double sweep function. Figure 13 compares the operation of the single and double sweep functions. Although most devices can be characterized using the single sweep function, some solar cells do exhibit a dependency on the sweep direction in their IV characteristics. In these cases the double sweep function permits easy characterization without the need to write any sort of a program.

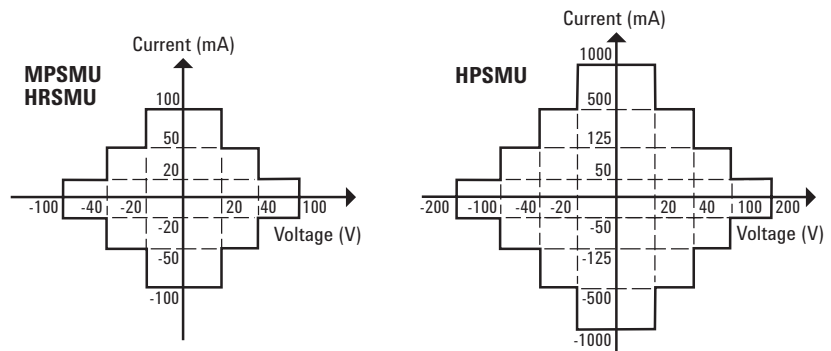

Figure 11. SMU current and voltage sourcing capabilities

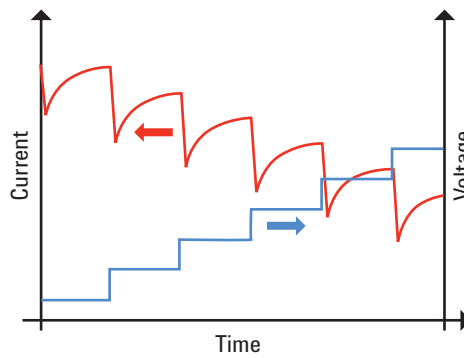

Figure 12. Step delay response of dye sensitized solar cell (DSC)

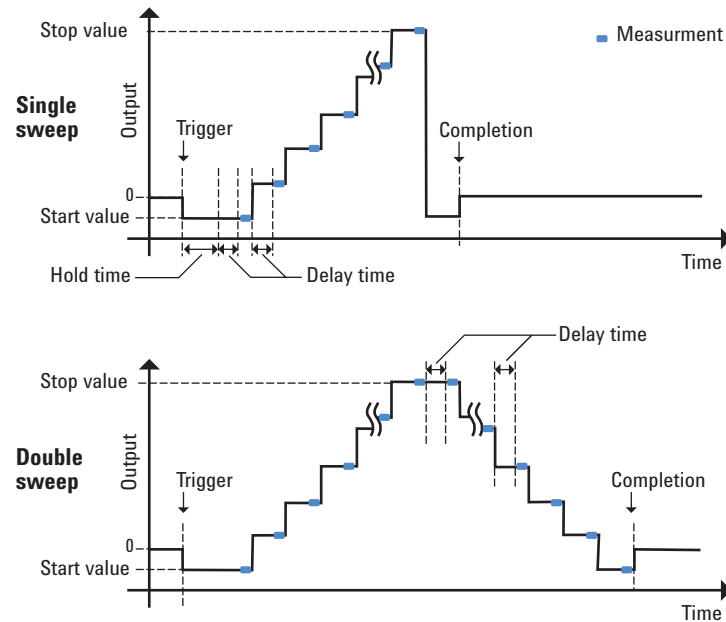

Figure 13. Comparison of the B1500A's single and double sweep functions



## Capacitance measurement capabilities

Capacitance measurements characterize the dynamic behavior of solar cells. As previously discussed, the Mott-Schottky Plot, Nyquist plot and DLCP are derived from capacitance measurements and they can show parameters such as the  $N_c$  and  $N_{dl}$  distribution over  $W$ .

In addition to basic DC bias voltage sweep capability, the B1500A's MFCMU also possesses frequency sweep and AC bias voltage sweep capabilities, which are required to evaluate the capacitance characteristics of solar cells. Table 4 summarizes the MFCMU's supported measurement ranges. In addition to eliminating the need for a separate external capacitance meter, the B1500A's MFCMU is completely integrated with its SMUs so that DC bias voltages up to  $\pm 100$  V can be applied to the solar cell.

## Time domain measurement capabilities

Time domain measurements can be used to evaluate recombination parameters such as  $\tau$ ,  $S$  and  $L_d$ . High-speed sampling capabilities are required to make these types of time domain measurements. An oscilloscope combined with some sort of an IV converter is often used for this purpose, although this involves integrating together a rack-and-stack solution.

The SMUs also have a time sampling function that enables you to make voltage versus time (V-t) and current versus time (I-t) sampling measurements. The sampling function can be

used to evaluate the transient characteristics of solar cells as described above. The minimum sampling interval and the time stamp resolution are both  $100 \mu s$ , which is sufficient to evaluate the solar cells exhibiting relatively slow transient responses to changes in their condition.

If the devices require IV measurement at a sampling rate faster than  $100 \mu s$ , the B1500A's WGFMU module is a possible option to evaluate

them. The WGFMU possesses a fast IV measurement capability that is synchronized with an arbitrary linear waveform generation (ALWG) function (please see Figure 14).

The ALWG function enables you to synthesize a variety of waveforms with  $10$  ns programmable resolution. The WGFMU has two modes, a PG mode and a Fast IV mode, and Table 5 summarizes the functions and ranges of the WGFMU in both modes.

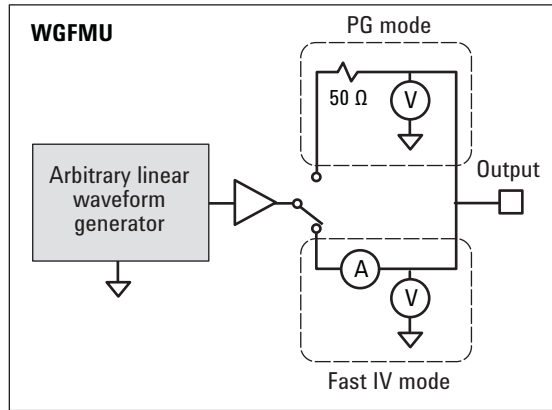

Figure 14. Simplified WGFMU circuit diagram

	Maximum	Minimum	Resolution
Frequency	5 MHz	1 kHz	1 mHz (Minimum)
Output signal level (rms)	250 mV	10 mV	1 mV
DC bias voltage	25 V (without SMU) 100 V (with SMU)	-25 V (without SMU) -100 V (with SMU)	1 mV
DC bias current	10 mA (50 $\Omega$ range)	—	—

Table 4. MFCMU measurement capabilities

Mode	Function	V force ranges	V measure ranges	I measure ranges
Fast IV	V force / I measure	-3 V to 3 V	-5 V to 5 V	1 $\mu A$
	V force / V measure	-5 V to 5 V	-10 V to 10 V	10 $\mu A$
		-10 V to 0 V		100 $\mu A$
		0 V to 10 V		1 $\mu A$ 10 $\mu A$
PG	V force / V measure	-3 V to 3 V -5 V to 5 V	-5 V to 5 V	—

Table 5. WGFMU functions and measurement ranges

## Software environment

EasyEXPERT is a powerful software environment resident on the B1500A. EasyEXPERT includes over 230 application tests, conveniently organized into logical categories. These application tests enable you to begin making productive solar cell parametric measurements immediately, eliminating the need to spend hours or days learning how to set up the instrument hardware. In addition, EasyEXPERT provides multiple data analysis features, including the ability to plot two or more sets of measurement data on the same Y axis, the capability to add multiple markers and pointers to graphs to emphasize important data points, and the ability to automatically calculate parameters from the measurement results. All of the application tests are user-modifiable, so it is easy to change them to meet the unique needs of your devices, such as adding additional measurement parameters or post-measurement calculated parameters.

## Additional measurement capabilities

The SMU CMU Unify Unit (SCUU) is useful if you need to make both IV and capacitance measurements (please see Figure 15). Because the SMUs and the MFCMU have different connector types, it is inconvenient and time-consuming to manually change the cabling connections when switching between IV measurements and capacitance measurements. The SCUU eliminates the need to manually change the cable connections. The B1500A application note B1500-3 (5989-3608EN) explains the SCUU operation in greater detail.

The B1500A mainframe has ten available slots, allowing you to make a B1500A configuration with up to ten SMUs. You can operate all of these SMUs in parallel when measuring solar cells to improve throughput. In addition, B1500A can communicate through GPIB etc with the other

external instruments, such as light sources and temperature chambers. You can develop an automated measurement system using the B1500A as the system controller for a variety of other instruments (please see Figure 16).

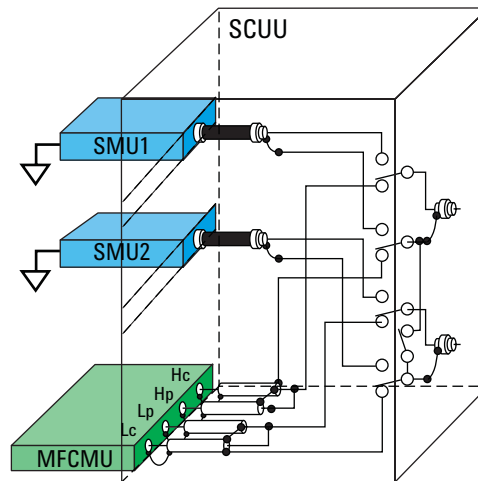

Figure 15. Details of SCUU connections

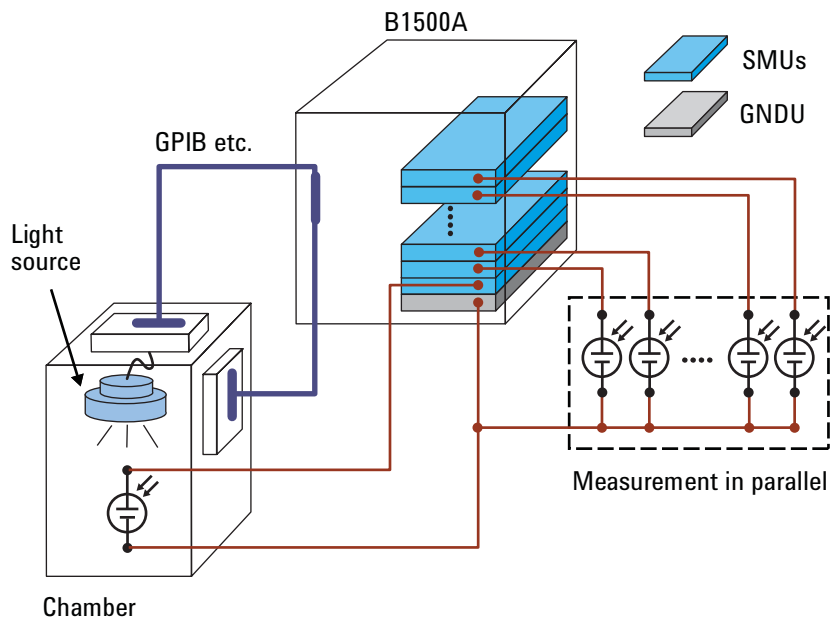

Figure 16. Measurement solution example showing parallel measurement and control of other instruments/equipment

# Sample application tests

Sample EasyEXPERT application tests for solar cells are available and they can be downloaded from the Agilent Web site. These sample application tests run on the B1500A and you can use them to evaluate your solar cells immediately without having to spend lots of time developing your own test programs. Table 6 lists the sample application tests, the measurements that they make and the extracted parameters. Figures 17 through 25 show actual measurement results obtained using these sample application tests.

**Solar Cell IV** makes a basic IV measurement to show the entire characteristics of the solar cell. You can specify various measurement parameters such as the start voltage, the stop voltage and the step voltage for the sweep measurement.

**Solar Cell IV Fwd** makes a forward biased IV measurement and estimates the basic static parameters of the solar cell, such as  $I_{sc}$ ,  $J_{sc}$ ,  $V_{oc}$ ,  $P_{max}$ ,  $I_{max}$ ,  $V_{max}$ ,  $FF$ ,  $\eta$ ,  $R_{sh}$  and  $R_s$ . In addition to these parameters, the application test also provides IV characteristics and power versus voltage characteristics.

Application test name	Type of measurement	Parameters & plots
Solar Cell IV	IV measurement	
Solar Cell Fwd	IV measurement	$I_{sc}$ , $J_{sc}$ , $V_{oc}$ , $P_{max}$ , $I_{max}$ , $V_{max}$ , $FF$ , $\eta$ , $R_{sh}$ , $R_s$
Solar Cell Rev	IV measurement	$R_{sh}$
Solar Cell Cp-V	C-V <sub>dc</sub> measurement	Mott-Schottky Plot, $N_c$
Solar Cell Nc-W	C-V <sub>dc</sub> measurement	$N_c$
Solar Cell Cp-Freq Log	C-f measurement	
Solar Cell Nyquist Plot	C-f measurement	Nyquist Plot
Solar Cell Cp-AC Level	C-V <sub>ac</sub> measurement	$N_{dl}$
Solar Cell DLCP	C-V <sub>ac</sub> measurement	$N_{dl}$

Table 6. List of sample application tests

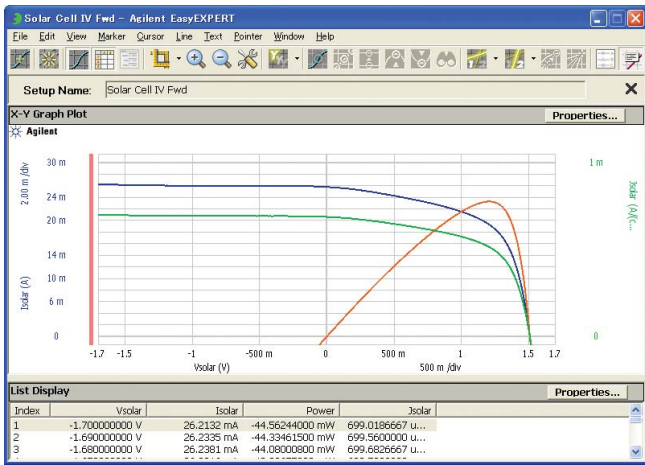

Figure 17. Application test (Solar Cell IV) example

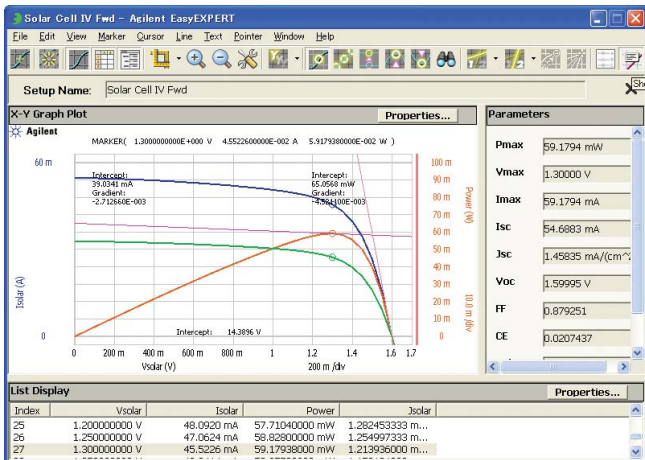

Figure 18. Application test (Solar Cell IV Fwd) example

**Solar Cell IV Rev** makes a reverse biased IV measurement and estimates the solar cell  $R_{sh}$  from the slope of the IV curve in the linear region.

**Solar Cell Cp-V** makes a capacitance measurement of the solar cell and shows the DC bias voltage dependency of the capacitance. In addition to CV characteristics, a Mott-Schottky plot is displayed and  $N_c$  is estimated from the result.

**Solar Cell Nc-W** also measures solar cell capacitance versus DC bias voltage and shows the W dependency of  $N_c$  estimated using a Mott-Schottky plot.

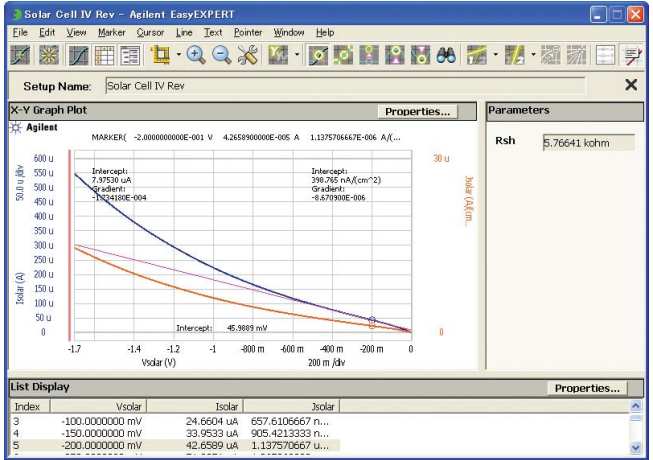

Figure 19. Application test (Solar Cell IV Rev) example

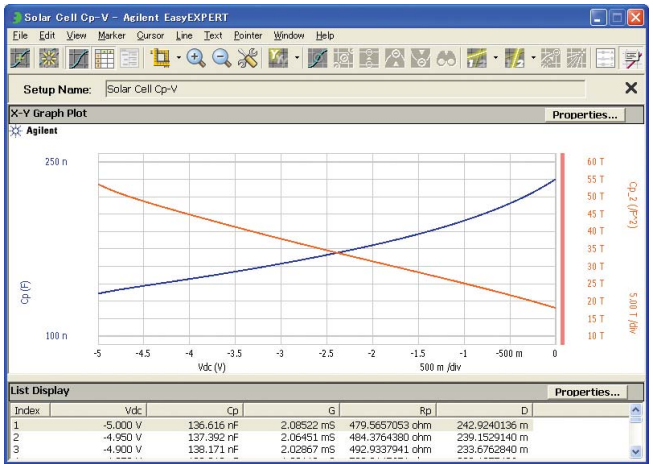

Figure 20. Application test (Solar Cell Cp-V) example

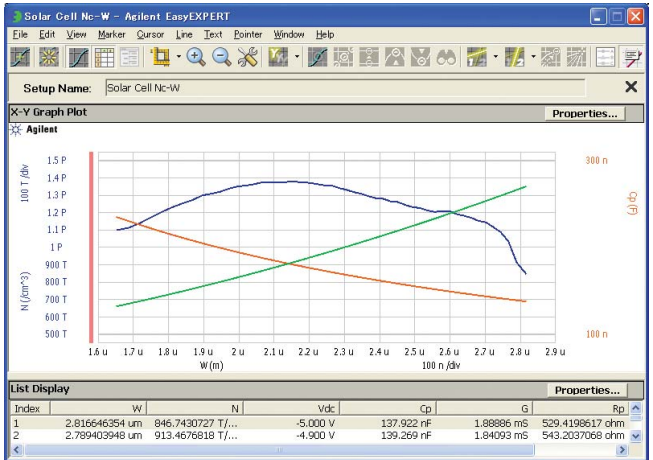

Figure 21. Application test (Solar Cell Nc-W) example

**Solar Cell Cp-Freq Log** measures solar cell capacitance versus AC signal frequency to determine the frequency dependency of the capacitance. Measurement conditions such as the start frequency, the stop frequency and the applied voltage can be specified.

**Solar Cell Nyquist Plot** also measures solar cell capacitance versus AC signal frequency and displays the frequency dependence of the impedance on the impedance plane. Measurement conditions such as the start frequency, the stop frequency and the applied voltage can be specified.

**Solar Cell Cp-AC Level** measures capacitance as a function of AC signal amplitude and shows the AC bias voltage dependency of the capacitance and estimates  $N_{dl}$  from the result. You can specify measurement conditions such as the start value, the stop value and the step value of the peak-to-peak voltage of AC signal, the DC bias voltage and the frequency of the AC signal. This measurement is also called DLCP.

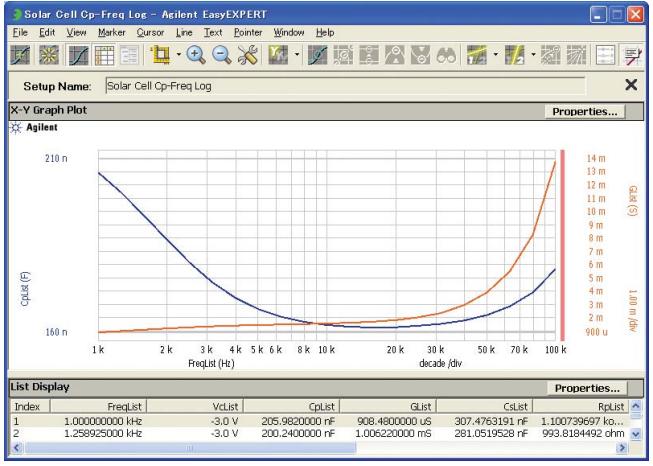

Figure 22. Application test (Solar Cell Cp-Freq Log) example

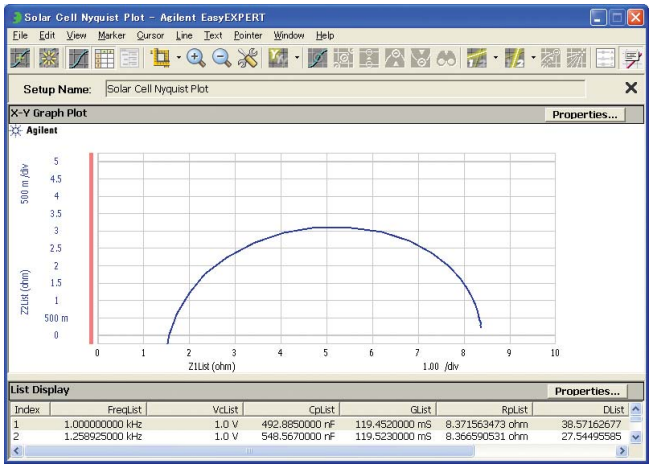

Figure 23. Application test (Solar Cell Nyquist Plot) example

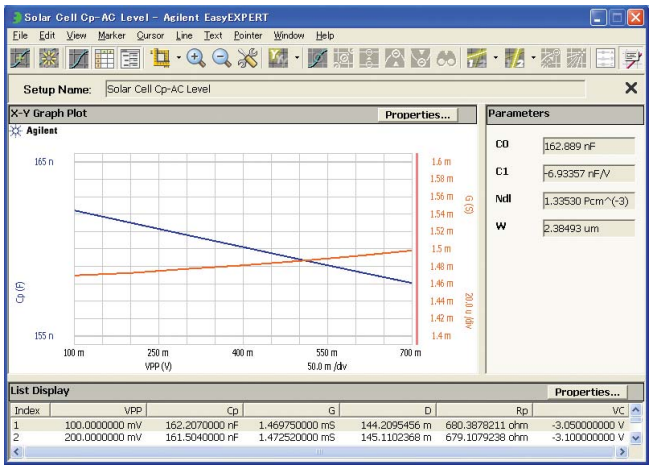

Figure 24. Application test (Solar Cell Cp-AC Level) example



**Solar Cell DLCP** also makes a capacitance measurement while changing both the DC bias and AC bias voltages and estimates  $N_{dl}$  from the result. After the measurement, the profile distance dependency of  $N_{dl}$  is shown. Measurement conditions such as the start DC voltage, the stop DC voltage, the step DC voltage, the start value, the stop value and the step value of the peak-to-peak voltage of the AC signal, and the frequency of the AC signal can be specified.

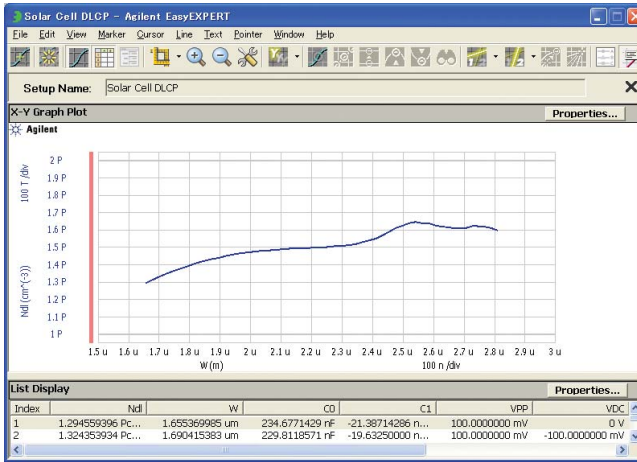

Figure 25. Application test (Solar Cell DLCP) example

## Conclusion

This application note has shown how the B1500A can be used to evaluate the characteristics of solar cells. The B1500A has a variety of modules (SMUs, MFCMU, WGFMU and HV-SPGU) that support all aspects of solar cell parametric test, from basic IV and capacitance characterization (such as CV,  $CV_{ac}$  and Cf) to ultra-fast IV time domain measurements.

EasyEXPERT provides an easy-to-use measurement environment that enables you to begin making productive solar cell parametric measurements immediately and eliminates wasted time spent learning how to set up the instrument hardware.

In addition to the over 230 application tests that are provided standard with EasyEXPERT, sample application tests for solar cell evaluation are available and can be downloaded from Agilent Web Site. This makes it easy to extract the basic solar cell parameters without the need to spend lots of time developing test programs.



### Agilent Email Updates

[www.agilent.com/find/emailupdates](http://www.agilent.com/find/emailupdates)

Get the latest information on the products and applications you select.



### Agilent Direct

[www.agilent.com/find/agilentdirect](http://www.agilent.com/find/agilentdirect)

Quickly choose and use your test equipment solutions with confidence.

## Remove all doubt

Our repair and calibration services will get your equipment back to you, performing like new, when promised. You will get full value out of your Agilent equipment through-out its lifetime. Your equipment will be serviced by Agilent-trained technicians using the latest factory calibration procedures, automated repair diagnostics and genuine parts. You will always have the utmost confidence in your measurements. For information regarding self maintenance of this product, please contact your Agilent office.

Agilent offers a wide range of additional expert test and measurement services for your equipment, including initial start-up assistance, onsite education and training, as well as design, system integration, and project management.

For more information on repair and calibration services, go to:

[www.agilent.com/find/removealldoubt](http://www.agilent.com/find/removealldoubt)

Product specifications and descriptions in this document subject to change without notice.

For more information on Agilent Technologies' products, applications or services, please contact your local Agilent office. The complete list is available at:

[www.agilent.com/find/contactus](http://www.agilent.com/find/contactus)

### Americas

Canada	(877) 894-4414
Latin America	305 269 7500
United States	(800) 829-4444

### Asia Pacific

Australia	1 800 629 485
China	800 810 0189
Hong Kong	800 938 693
India	1 800 112 929
Japan	0120 (421) 345
Korea	080 769 0800
Malaysia	1 800 888 848
Singapore	1 800 375 8100
Taiwan	0800 047 866
Thailand	1 800 226 008

### Europe & Middle East

Austria	01 36027 71571
Belgium	32 (0) 2 404 93 40
Denmark	45 70 13 15 15
Finland	358 (0) 10 855 2100
France	0825 010 700*
	*0.125 €/minute
Germany	07031 464 6333
Ireland	1890 924 204
Israel	972-3-9288-504/544
Italy	39 02 92 60 8484
Netherlands	31 (0) 20 547 2111
Spain	34 (91) 631 3300
Sweden	0200-88 22 55
Switzerland	0800 80 53 53
United Kingdom	44 (0) 118 9276201

Other European Countries:

[www.agilent.com/find/contactus](http://www.agilent.com/find/contactus)

Revised: March 24, 2009

© Agilent Technologies, Inc. 2009  
Printed in USA, August 12, 2009  
5990-4428EN



**Agilent Technologies**